



Summerset[®]

PROFESSIONAL GRILLS



ABOUT SUMMERSET

Summerset Professional Grills offers a complete line of stainless steel grills, grill carts, BBQ Islands, fire pits, doors, drawers, components and more. Our commitment to quality is reflected in the craftsmanship of our product and is fully supported by the Summerset Warranty.

OVER 20 YEARS OF LEADERSHIP

Summerset Professional Grills is a company born of experience. With 20 years of leadership branding and manufacturing, our core focus is clear — to provide consumers with exceptional service and outstanding quality at a great value.

RELIABLE PRODUCTS FOR EVERY BUDGET

Summerset strives to meet every outdoor living expression. We offer a wide range of affordable products from our Sizzler Series all the way up to our Alturi Series, without sacrificing an ounce of quality. No matter the budget Summerset will deliver an outdoor experience that will create fond memories for years to come.

SUPERIOR QUALITY

Here at Summerset we pride ourselves on using only the best materials. All our products are made with the highest—grade stainless steel available, designed to withstand the high temperatures and greasy environments of outdoor cooking. We strive to maintain excellence in all we do and the result is a product you can count on.





SIZZLER SERIES

Quality you can afford. The latest addition to the Summerset line, the Sizzler Series is a premium product at an unbeatable price. Constructed in all #443 stainless steel* and designed with careful precision to ensure optimal airflow and even heating, this grill gives its higher-priced competitors a run for their money in both durability and grilling performance. The Sizzler will impress the most discriminating of grillers.



SIZZLER 26" GRILL siz26

Cooking Surface: 550 sq. in.
Dimensions: (W) 23^{3/4} x (H) 8^{1/2} x (D) 20^{3/4}



SIZZLER 32" GRILL siz32

Cooking Surface: 795 sq. in.
Dimensions: (W) 30^{5/8} x (H) 8^{1/2} x (D) 20^{3/4}



SIZZLER 40" GRILL siz40

Cooking Surface: 985 sq. in.
Dimensions: (W) 38 x (H) 8^{1/2} x (D) 20^{3/4}



SIZZLER 40" CART CART-SIZ40

#433 Stainless Steel Construction
Fixed Shelves, Locking Casters



FEATURES

- #443 Stainless Steel Construction
- Double-Lined Hood
- 8mm Cooking Grates
- 12,000 BTU #304 Stainless Burners
- 15,000 BTU IR Rack Burner
- 15,000 BTU Drop-In Sear Burner Available
- Flame Thrower Ignition
- Manual Flash Tube Ignition
- Easy-Clean Briquette Systems
- Built-In and Cart Models Available
- Matching Side Burner Available
- Rotisserie Kits Available



SIZZLER PRO SERIES

The all new Sizzler Pro Series packs tons of features on top of quality construction and affordability. Upholding the same sleek design as the our classic Sizzler along with the added Exterior LED Lights, this grill really set itself apart. The interior has also been revamped with 14,000 BTU Cast Burners, Heat Zone Separators and Interior Cooking Lights to make for a premium grilling experience from top to bottom. The best part is...it won't break your wallet.



SIZZLER PRO 32" GRILL SIZPRO-32

Cooking Surface: 795 sq. in.
Dimensions: (W) 30^{5/8} x (H) 8^{1/2} x (D) 20^{3/4}



SIZZLER PRO 40" GRILL SIZPRO-40

Cooking Surface: 985 sq. in.
Dimensions: (W) 38 x (H) 8^{1/2} x (D) 20^{3/4}



SIZZLER PRO CART CART-SIZPRO

#443 Stainless Steel Construction
Fixed Shelves, Locking Casters
Available for all models



FEATURES

- #443 Stainless Steel Construction
- Double—Lined Hood
- 8mm Cooking Grates
- 14,000 BTU #304 Cast Burners
- 15,000 BTU IR Rack Burner
- Heat Zone Separators
- Exterior LED Lighting
- Interior Cooking Lights
- Flame Thrower Ignition
- Rotisserie Kits Available
- Easy-Clean Briquette System
- Built-In and Cart Models Available
- Matching Side Burner Available
- Manual Flash Tube Ignition
- Stainless Steel Carts Available
- 15,000 BTU Drop-In Sear Burner Available



TRL SERIES

The TRL is a fully loaded workhorse, a grilling classic packed with luxury features. Complete with interior lights, exterior LEDs, a rear infrared burner, full rotisserie set, flame thrower valves, easy clean briquette burner covers and plug-and-play infrared sear zone options, the TRL makes professional grilling easy. With a commercial-grade stainless steel construction and 16-gauge stainless steel burners backed by lifetime warranty, this grill is built to last.



TRL 32" GRILL TRL32

Cooking Surface: 925 sq. in.
Dimensions: (W) 30^{1/2} x (H) 10 x (D) 20^{3/4}



TRL 38" GRILL TRL38

Cooking Surface: 1156 sq. in.
Dimensions: (W) 38^{1/2} x (H) 10 x (D) 20^{3/4}



TRLD 44" GRILL TRLD44

Cooking Surface: 1251 sq. in.
Dimensions: (W) 45^{1/8} x (H) 11 x (D) 20



TRLD 44" CART CART-TRLD

#443 Stainless Steel Construction
Double Door Storage
Folding Shelves (Deluxe upgrade)



FEATURES

- #304 Stainless Steel Construction
- Double—Lined Hood
- 8mm Cooking Grates
- 18,000 BTU #304 Stainless Burners
- 15,000 BTU IR Rack Burner
- Easy-Clean Briquette System
- Flame Thrower Ignition
- Rotisserie Kits Included
- 15,000 BTU Drop-In Sear Burner Available
- Manual Flash Tube Ignition
- Matching Side Burner Available
- Heavy-Duty Stainless Steel Knobs
- Built-In and Cart Models Available
- Exterior LED and Interior Halogen Lighting

DELUXE UPGRADES

- 20,000 BTU Cast Stainless Burners
- Heavy Duty Double—Lined Hood
- Dual Halogen Interior Lighting
- Heavy-Duty 9mm Cooking Grates
- Heat-Zone Separators



ALTURI SERIES

The Alturi Series can be summed up in one word — luxury. Designed with elegance, fueled with raw power and loaded with every feature, this grill sets the bar for luxury outdoor cooking. Details like the angle-mounted interior lights, rotisserie storage and spring-assisted hood provide ultimate convenience, while its solid #304 stainless steel construction and high BTU Red Brass burners - the most durable in the market - guarantee lasting performance. When it comes to performance, quality and style, Alturi truly stands alone.



ALTURI 30" GRILL ALT30

Cooking Surface: 815 sq. in.
Dimensions: (W) 28^{1/2} x (H) 10^{3/16} x (D) 23^{1/16}



ALTURI 36" GRILL ALT36

Cooking Surface: 1028 sq. in.
Dimensions: (W) 34^{1/4} x (H) 10^{3/16} x (D) 23^{1/16}



ALTURI 42" GRILL ALT42

Cooking Surface: 1220 sq. in.
Dimensions: (W) 40^{1/2} x (H) 10^{3/16} x (D) 23^{1/16}



ALTURI 30" CART ALTURI CART

#443 Stainless Steel Construction
Double Door Storage, Folding Shelves
Available For All Models



FEATURES

- #304 Stainless Steel Construction
- Heavy Duty Double—Lined Hood
- 26,000 BTU Main Burners
- Interior Halogen Lighting
- LED Front Panel Lighting
- Heavy-Duty 9mm Cooking Grates
- Heat-Zone Separator
- Flame Thrower Ignition
- Easy-Clean Briquette System
- Rotisserie Kit Included
- Drop-In Sear Burner Available
- Built-In and Carts Models Available
- Matching Side Burner Available
- Red Brass and Stainless Tube Burners Available



BUILDER GRILL

The Summerset Builder Grill is the newest member of the Summerset Grill team. Whether it is an apartment community, hotel, or country club, these environments get a great deal of extra use and abuse. Donning the same beefed-up body as our luxury Alturi series, The Builder Grill is made with solid #304 stainless steel construction, 9mm cooking grates, and extra thick 14 gauge stainless steel flame tamers. Available in both built-in and cart models, this grill is the perfect match for any commercial application.



BUILDER GRILL SBG-32

Cooking Surface: 541 sq. in.
(W)28^{1/2} x (H) 10^{3/16} x (D) 23^{1/16}



BUILDER GRILL PEDESTAL SBG-PED

#304 Stainless Steel Construction
Double Door Storage
Anti-theft Locking Doors

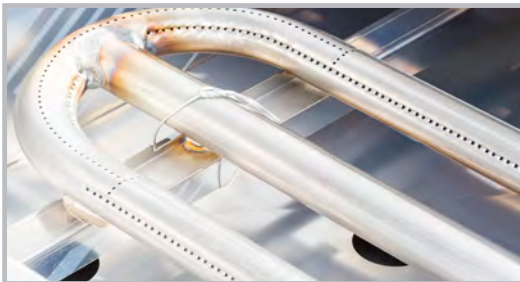

FEATURES

- Available Only in 32" Size
- Total BTUs 52,000
- #304 Stainless Steel Construction
- Double—Insulated Hood
- 9mm Cooking Grates
- 26,000 BTU #304 Stainless Burners
- 14 Gauge Flame Tamers
- Flame Thrower Ignition
- Stainless Steel Pedestal Available
- Rolling Drip Tray
- Heavy Duty Anti-Theft Knobs
- Timer Available
- LP Conversion Kit Included
- Built-in Option (SBG-32)
- Pedestal Option (SBG-PED)

GAS
CHARCOAL
INFRARED
PELLETS
WOOD



AMERICAN MUSCLE GRILL



AMG 36 AMG-36
Cooking Surface: 1105 sq. in.
(W) 35 x (H) 15 x (D) 25



AMG CART AMG-CART
#443 Stainless Steel Construction
Soft Close Double Lined Storage Drawers
Locking Casters

FEATURES

- #304 Stainless Steel Construction
- 36" and 54" sizes
- 16 Gauge Double-Lined Hood
- Full width hood handle
- Spring-assisted hood
- Hood vents for heat control
- 14 Gauge #304 stainless steel burners
- Reversible V-shaped grates for cooking versatility
- Removable 12 gauge burner covers and solid fuel trays
- Plug and pay Infrared burner in 4 of 5 burner positions
- High efficiency interior cooking lights
- LED lights over each knob
- Easy-clean drip pan with drain system
- High air flow design
- Solid brass, flame thrower valve ignition
- Comes with leather gloves, grate tool and head cover
- Built in rotisserie spit storage
- Available commercial grade rotisserie with 100 lb. motor
- Tested to the ANSI Z21.58/ CGA 1.6
- Built, factory tested, and serviced in the USA.





BURN IT ALL

We can argue all day about what fuel is “best” for a BBQ. Well, let’s kill the argument by burning it all. Park your stress and rev up this multi-fuel monster, enjoying the bounty of charcoal, gas, wood-chunks, pellets, and infrared, all in a single barbecue. Gas is convenient, so either cook with it, or simply use it to ignite your solid fuels in just seconds—or do it all. It’s the best of every world. The biggest decision you’ll make is how big you want it: 36 or 54 inches. Big, or BIG.

ACCESSORIES



Grill Gloves



Grate Tool



Sear Burner

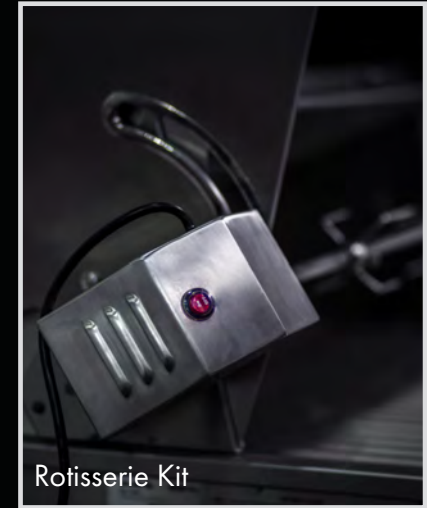

Rotisserie Kit



Grill Cart Cover



Grill Cover

AMG 3.6

SIDE BURNERS

We've combined the comfort of an indoor kitchen range with all the benefits of being outside. Specially designed for performance and function, a Summerset Side Burner is the perfect addition to your outdoor kitchen. Commonly used for finish cooking, sauces, or heating foods that require lower, more controlled temperatures than your grill, a side burner offers the convenience of range top cooking and grilling simultaneously. Find the perfect side burner for your outdoor kitchen with four professional lines to choose from: Sizzler, TRL, TRLD, and the luxurious Alturi. All Summerset Side Burners feature stainless steel construction, heavy stainless steel grates, and up to 35,000 BTUs of power, all packed in a sleek design, and backed by an unbeatable warranty.



ALTURI DOUBLE SIDE BURNER ALT-2B

Total BTUs: 35,000
Solid Brass Burners
Cooking Surface: 21 1/2 x 11 1/2
Front Panel LED Lighting



SIZZLER DOUBLE SIDE BURNER SIZSB-2

Total BTUs: 24,000
Cooking Surface: 19 1/2 x 10 1/2



ALTURI SIDE SEAR BURNER ALT-SS

Total BTUs: 18,000
Infrared Burner (Up to 1600°F)
Adjustable High/Low Technology
Cooking Surface: 21 1/4 x 11 1/2
Front Panel LED Lighting



SEAR SIDE BURNER SSEAR-1

Total BTUs: 15,000
Infrared Burner (Up to 1600°F)
Adjustable High/Low Technology
Cooking Surface: 18 1/2 x 11 1/2



TRL DOUBLE SIDE BURNER TRLSB-2

Total BTUs: 30,000
Cooking Surface: 19 1/4 x 11 1/4
Front Panel LED Lighting



SINGLE SIDE BURNER SSSB-1

Total BTUs: 15,000
Cooking Surface: 9 1/2 x 9 1/2

POWER BURNER

Turn up the heat in your outdoor kitchen with the all-new Summerset Power Burner. The Power Burner features a cast stainless burner with dual burner rings for temperature control that boasts up to 60,000 BTUs. With a removable center grate system that allows for wok cooking as well as large pots and pans, you'll never run out of recipes to try. The power burner also comes with front panel LED lighting that will compliment any of our Summerset Grills.



POWER BURNER

SSPB-1

Total BTUs: 60,000

Cooking Surface: 13^{1/2} x 17^{1/4}

Front Panel LED Lighting



LIGHTING INSTRUCTIONS
1. Please read instructions before lighting.
2. Open lid and turn lighting burners
3. Turn control knob to "ON" position.
4. Push igniter button on control panel.
5. If burner does not light, repeat steps 2-4.
6. If burner still does not light, repeat steps 2-4.
7. If burner still does not light, repeat steps 2-4.
8. If burner still does not light, repeat steps 2-4.
9. If burner still does not light, repeat steps 2-4.
10. If burner still does not light, repeat steps 2-4.



BACKLIT
OFF

ON

IGNITER
LIGHT

SUMMERSET BBQ ISLANDS

Enjoy creating new memories and exciting conversations with your family and friends around our custom BBQ Islands. All Summerset Professional Islands are constructed with rust-resistant 1" x 1" welded-steel framing, trex railing systems and complete electrical systems. Islands include stucco finish and porcelain tile counter-tops, with Ameristone and granite upgrades available. All models are available to order finished, partially-finished or unfinished.



- MAUI



- CATALINA



- OAHU



- PORTAFINO

GRANITE TILE



Baltic Brown Tan Brown Tropical Tan Uba Tuba New Venetian Gold Black Galaxy

AMERISTONE FINISH

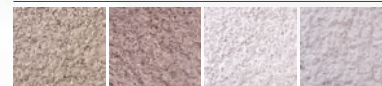

River Rock Stony Creek Champagne Gray Pearl Haze

STUCCO FINISH

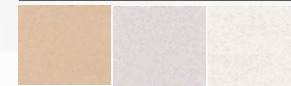

Sandalwood Beige Overcast Natural White

PORCELAIN TILE

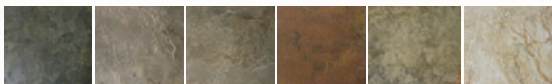

Vasai Modasa Satara Thane Tenali Kalva



SUMMERSET FIRE PITS

Now you can have all the warmth and comfort of your living room in your own backyard. All SummerSet Professional Fire Pits are constructed with rust-resistant 1" x 1" welded-steel framing. Fire Pits include installation lines, fire glass, a stainless steel access door and a high-quality 140,000 BTU, #304 stainless steel burner. All fire pits are available in porcelain or granite tops, and with stucco or Ameristone finishes.



- TUSCANY



- MILAN



- SIENA



- VENICE

GRANITE TILE

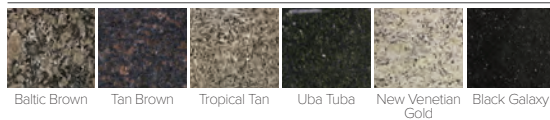

PORCELAIN TILE



AMERISTONE FINISH



STUCCO FINISH

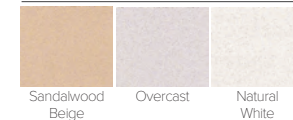

COLD STORAGE

REFRIGERATION

Enjoy fresh ingredients and chilled beverages with Summerset Stainless Steel Refrigerators. With up to 5.5 cubic feet of storage and glass shelving, these appliances will facilitate food preparation and storage needs for your outdoor kitchen. All Summerset Refrigerators offer durable construction for the outdoors, temperature control, adjustable legs for leveling, and sleek design for function and beauty. Bring the function of your indoor refrigerator outside with matching performance and design.



OUTDOOR RATED REFRIGERATOR
ORFR-1

Storage Capacity: 5.4 ft³
Full Stainless Steel Construction
Sealed Back For Energy Efficiency
Quick Cool Technology
UL Certified For Outdoor Use
Door w/ Lock & Key
Digital Thermostat
Overall Dimensions:
(W) 24 x (H) 33¹/₄ x (D) 25



ALTURI REFRIGERATOR
ALTRFR-1

Storage Capacity: 4.6 ft³
#304 Stainless Steel Door w/ Lock & Key
Interior Light
Glass Shelving
Crisping Drawers
Door w/ Lock & Key
Overall Dimensions:
(W) 22 x (H) 33¹/₂ x (D) 24



SUMMERSET REFRIGERATOR
SSRFR-1B

Storage Capacity: 4.6 ft³
Reversible Door w/ Lock & Key
Interior Light
Glass Shelving
Door w/ Lock & Key
Crisping Drawers
Overall Dimensions:
(W) 22 x (H) 33¹/₂ x (D) 24

ICE CHEST

With our grills heating things up, we have just what you need to keep cool. Choose between two sizes to optimize your serving station. With up to 40 lbs. of ice capacity, load 'em up with refreshments, snacks or ingredients to make for a good time and easy grilling.



LARGE ICE CHEST
SSIC-1



SMALL ICE CHEST
SSIC-2

BARS AND SINKS

Take your outdoor kitchen to the next level with the Beverage Center. Complete with an ice compartment, sink, towel holder, speed rail with condiment tray and built-in bottle opener, this will make you the best host in the neighborhood. Don't worry, when the sun goes down the LEDs will light it up and keep the party going!



OUTDOOR SINK
SSNK-2



LIGHTED BEVERAGE CENTER
SSBCL-1



SUMMERSET REFRIGERATOR DOOR SLEEVE
SSRSL-1/SSRSL-1R



SUMMERSET REFRIGERATOR TRIM KIT
SSRTRK-1





OUTDOOR KITCHEN COMPONENTS

Bring function and convenience to your outdoor kitchen with Summerset components. Providing utility options, easy access to your BBQ Island, and storage solutions for tools and utensils, our doors and drawers will make your outdoor kitchen efficient and functional. For a wonderfully sleek built-in look, all components feature easy flush mounting, reversible door mounting, and a handy magnetic latch to keep it all secure. Made with complete #304 construction and backed by a limited lifetime warranty, Summerset components are built to last.

ACCESS DOORS



MINI VERTICAL DOOR
SSMD-1



VERTICAL DOOR
SSDV-1



LARGE VERTICAL DOOR
SSDVL-1



HORIZONTAL DOOR
SSHD-1



30" DOUBLE DOOR
SSDD-30



42" DOUBLE DOOR
SSDD-42

STORAGE DRAWERS



SINGLE DRAWER
SSDR-1



DOUBLE DRAWER
SSDR-2



TRIPLE DRAWER
SSDR-3



DOOR/2-DRAWER COMBO
SSDC-1



DOOR/3-DOOR COMBO
SSDC-3



TOWEL/2-DRAWER COMBO
SSTDC-1

STORAGE DRAWERS



UTILITY DRAWER
SSUD-1



DOUBLE HORIZONTAL
DRAWER
SSHDR-2



TRIPLE HORIZONTAL
DRAWER
SSHDR-3



TOWEL DRAWER HOLDER
SSTDH-1



LIQUID PROPANE DRAWER
SSLPD-1



TRASH DRAWER
SSTD-1

ISLAND ACCESSORIES



ISLAND VENT
SSIV-1

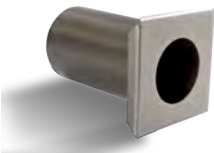

UMBRELLA STANCHION LG/SM
SSUS-1/SSUS-1L



CUTTING BOARD/TRASH CHUTE
SSTC-1



MASONRY COMPONENTS

Summerset™ Masonry Components are perfect for islands with stone or brick finishes. The increased flange depth makes for a seamless fit and streamlined installation. With the durability of complete #304 stainless steel construction, these components can also be used to add an attractive contrast to any island with stucco or Ameristone finishes.

ACCESS DOORS



LARGE VERTICAL DOOR
SSDVL-M



30" DOUBLE DOOR
SSDD-30M



42" DOUBLE DOORS
SSDD-42M

STORAGE DRAWERS



DOUBLE DRAWER
SSDR-2M



TOWEL/2-DRAWER COMBO
SSTDC-M



TRASH DRAWER
SSTD-M



DOOR/2-DRAWER COMBO
SSDC-M

ACCESSORIES



ISLAND VENT
SSIV-M

SUMMERSET ACCESSORIES

GRILL COVERS

Protect your outdoor kitchen with Summerset Grill Covers. Our heavy-duty PVC covers are 100 percent water resistant, UV protected to prevent fading, and feature flannel backing (to keep your steel scratch-free). Covers also available for Side Burners and Fire Pits.



GRILL COVER
GRILLCOV



CART COVER
CARTCOV

GRILL & SIDE BURNER LINERS

Summerset Grill Liners are made with #304 stainless steel to protect any outdoor kitchen made of combustible material. The fitted Grill Liners provide an inch of double-walled insulation that blocks the heat from reaching combustible surfaces or framing such as wood or plastic, giving you the freedom to create your outdoor kitchen in the material of your choice.



GRILL LINER
GL-SS



SIDE BURNER LINER
GL-SB

SEAR BURNERS

Become the chef you've dreamed of by using Summerset Sear Burners. Our sear burners can replace any burner position giving you a customizable cooking experience, allowing you to burn and turn the way you want. Crank up the heat and lock in the flavor, leaving your family and friends with a meal they'll never forget.

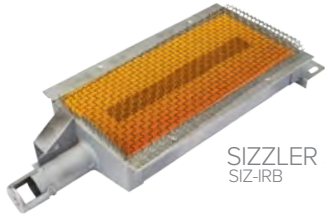

SIZZLER SEAR BURNER
SIZ-IRB

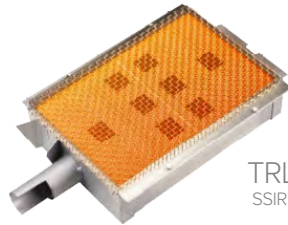

TRL SEAR BURNER
SSIRB-L

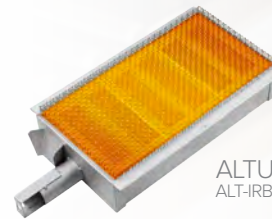

ALTURI SIDE BURNER
ALT-IRB

ROTISSERIE KIT STORAGE BAG

When you're not cooking a 15 lb. turkey or searing a delicious rotisserie chicken, keep your Rotisserie Kit clean and consolidated with the Rotisserie Kit Storage Bag. The Storage Bag helps protect the motor from the elements and the components from the critters. No matter what size kit you have we have the bag to store it in.



ROTISSERIE KIT STORAGE BAG
RSB-SM (26-32) • RSB-LG (36-44)
*Rotisserie Kit Sold Separately

SMOKER TRAY

Add some flavor and pizzazz to an otherwise ordinary meal with the Summerset Smoker Tray. Whether it's mesquite chicken or applewood smoked salmon, the smoker tray is the ultimate meal enhancer that allows for endless flavor options.



SMOKER TRAY
SSMK-SIZ SSMK-TRL

CUTOUT DIMENSIONS

Measure twice, cut once. In this case we've done the measuring for you. Use the diagram below as a reference to customize your outdoor kitchen with efficiency and style.

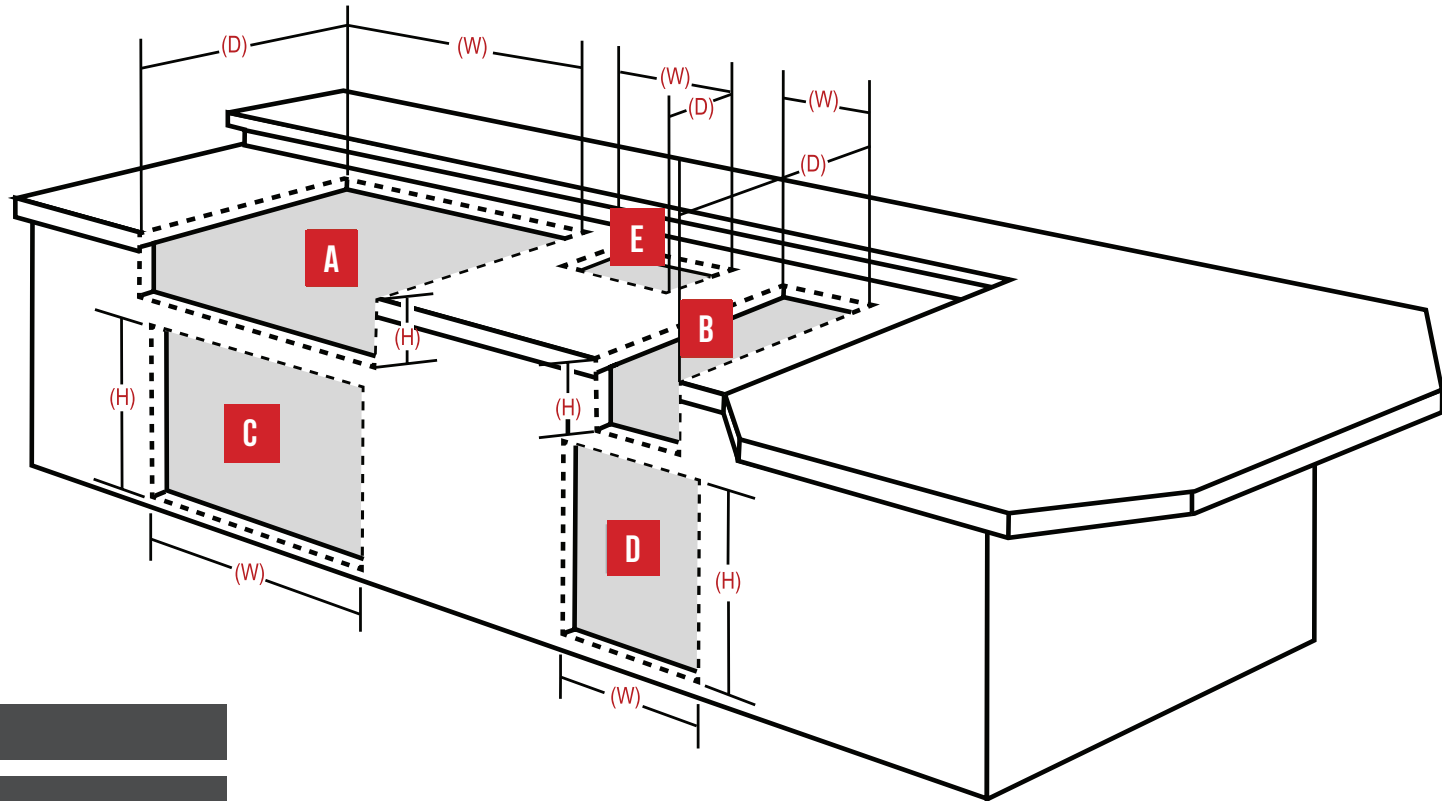

- A** GRILLS
- B** SIDE BURNERS
- C** DOORS
- D** DRAWERS
- E** UTILITY COMPONENTS

Product	Model #	Cutout Dimensions	Diagram
GRILLS			
		(W x H x D)	
Builder Grill	SBG32	28½" x 10 ³ / ₁₆ " x 23 ¹ / ₁₆ "	A
Sizzler 26" Grill	SIZ26	23¾" x 8½" x 20¾"	A
Sizzler/PRO 32" Grill	SIZ32	30⅝" x 8½" x 20¾"	A
Sizzler/PRO 40" Grill	SIZ40	38" x 8½" x 20¾"	A
TRL 32" Grill	TRL32	30½" x 10" x 20¾"	A
TRL 38" Grill	TRL38	38½" x 10" x 20¾"	A
TRLD 44" Grill	TRLD44	45¼" x 11" x 20"	A
Alturi 30" Grill	ALT30	28½" x 10 ³ / ₁₆ " x 23 ¹ / ₁₆ "	A
Alturi 36" Grill	ALT36	34½" x 10 ³ / ₁₆ " x 23 ¹ / ₁₆ "	A
Alturi 42" Grill	ALT42	40½" x 10 ³ / ₁₆ " x 23 ¹ / ₁₆ "	A
AMG 36" Grill	AMG-36	35" x 15" x 25"	A
SIDE BURNERS			
		(W x H x D)	
Single Side Burner	SSSB-1	8" x N/A x 15½"	B
Sizzler Double Side Burner	SIZSB-2	10¾" x 8½" x 20¾"	B
TRL Double Side Burner	TRLSB-2	11¾" x 9" x 19"	B
Sear Side Burner	SSEAR-1	11¾" x 9" x 19"	B
Alturi Double Side Burner	ALT-2B	13¼" x 10¼" x 23"	B
Alturi Sear Side Burner	ALT-SS	13¼" x 10¼" x 23"	B
Power Burner	SSPB-1	13¾" x 9½" x 19"	B
REFRIGERATION			
		(W x H x D)	
Summerset / Alturi Refr.	SSRFR-1, ALTRFR-1	22" x 33½" x 24"	D
Outdoor Rated Refrigerator	ORFR-1	24" x 33¼" x 25"	D
Refrigerator Trim Kit	SSRTK-1	22¼" x 33½" x N/A	D
Outdoor Rated Trim Kit	ORFR TK-1	24 ³ / ₁₆ " x 33 ³ / ₁₆ " x N/A	D

Product	Model #	Cutout Dimensions	Diagram
DOORS			
		(W x H x D)	
Vertical Mini Door	SSMD-1	14¼" x 16¼" x N/A	C
Vertical Door	SSDV-1, ALTDV-1	14¼" x 19¼" x N/A	C
Vertical Door Large	SSDVL-1, SSDVL-M, ALTDVL-1	17¼" x 24¼" x N/A	C
Horizontal Door	SSHD-1, ALTHD-1	24¼" x 17¼" x N/A	C
Double Door 30"	SSDD-30, SSDD-30M, ALTDD-30	30¼" x 19½" x N/A	C
Double Door 42"	SSDD-42, SSDD-42M, ALTDD-42	42¼" x 19½" x N/A	C
Door/2-Drawer Combo	SSDC-1, SSDC-M, ALTDC-1	30¼" x 19½" x 20¾"	C
Door/3-Drawer Combo	SSDC-3	29¾" x 20⅝" x 20½"	C
DRAWERS			
		(W x H x D)	
Utility Drawer	SSUD-1, ALTUD-1	23¼" x 4" x 20¾"	C
Single Drawer	SSDR-1, ALTD-1	15¾" x 10⅝" x 20¾"	D
Double Drawer	SSDR-2, SSDR-2M, ALTD-2	15¾" x 19¼" x 20¾"	D
Triple Drawer	SSDR-3, ALTD-3	15¾" x 27¾" x 20¾"	D
Double Horizontal Drawer	SSHDR-2	30⅝" x 6¼" x 20⅝"	D
Triple Horizontal Drawer	SSHDR-3	46" x 6¼" x 20⅝"	D
Liquid Propane Drawer	SSLPD-1	*Please Call For Dim.	C
Trash Drawer	SSTD-1, SSTD-M, ALTTD-1	18" x 24¾" x 20½"	D
Towel Drawer Holder	SSTDH-1, ALTTDH-1	14¾" x 8¾" x 8¾"	D
Towel/2-Drawer Combo	SSTDC-1, SSTDC-M, ALTTDC-1	15¼" x 27¾" x 20¾"	D
UTILITY COMPONENTS			
		(W x H x D)	
Trash Chute	SSTC-1, ALTTC-1	6¼" x N/A x 8¼"	E
Beverage Center	SSBCL-1	28¼" x 10" x 23⅝"	B
15" Sink & Faucet	SSNK-2	14⅝" x N/A x 14⅝"	B
Ice Chest Large	SSIC-1	26¾" x 18¾" x 19½"	E
Ice Chest Small	SSIC-2	15½" x 11¾" x 23"	E
Island Vent	SSIV-1, SSIV-M	12½" x 3 ¼" x N/A	-

- For any additional information on cutouts, please call us at 1-800-966-8126

WARRANTY

SUMMERSET SERIES

Summerset Professional Grills' Limited Lifetime Warranty claims are valid for original purchaser at original site of delivery with proof of purchase and photo documentation. Given that the Outdoor Gas Grill is subject to normal residential use, it will be covered by this warranty for the duration of time specified below.

- Limited Lifetime warranty on construction and manufacturer defects
- Limited Lifetime warranty on frame and housing
- Limited Lifetime warranty on cooking grates, burners and valves
- 1 year warranty on all other parts, components, and electrical

Warranty does not cover commercial or rental applications. It does not cover discoloration, surface rust, corrosion, or oxidation, which may occur due to harsh environments, chemicals or overheating. Warranty does not cover damage resulting from improper installation, abuse, alterations, misuse, or improper care. All warranties are subject to manufacturer review. Warranty covers replacement parts only. It does not cover labor or labor related charges. Registration form for appliances must be submitted within 30 days of purchase date to validate the above warranty.

BUILDER GRILL

1 year limited warranty on workmanship and parts for all commercial and/or hospitality applications. Warranty covers all factory defects. Warranty does not cover regular cleaning, vandalism, misuse, or theft. All warranty claims are subject to manufacturer review. Warranty is valid only provided that regular maintenance is exercised. Due to the nature of commercial applications (multiple users, lack of control of use, etc.) regular maintenance is mandatory.

AMG SERIES

- Limited Lifetime warranty on construction and manufacturer defects
- Limited Lifetime warranty on frame and housing
- Limited Lifetime warranty on cooking grates, burners and valves
- Limited Lifetime warranty on burner cover and fuel trays
- 1 year warranty on all other parts, components, and electrical

To get more warranty details and maintenance tips visit www.americanmusclegrill.com.

Warranty is valid for original purchaser with proof of purchase only. Warranty is void upon transfer of ownership. Warranty does not apply to products installed in any commercial or non-residential application. Warranty covers replacement parts only. Manufacturer is not responsible for labor or labor costs. Warranty will not apply for damage resulting from improper installations, abuse, extreme environments, grease fires, or misuse. Coastal, humid, and/or salt environments are subject to manufacturer review. All out-of-box claims must be made within 30 days of purchase, not installation. All warranty claims are valid only with proof of purchase and photo documentation of defective part. Warranty and registration forms are available at www.Summersetgrills.com. Contact your local dealer to submit claims. Please be advised that all display models are sold "as is" and are subject to the following warranty exclusions: any exterior or cosmetic damage; any missing components will be replaced at the consumer's expense; all other warranty's (standard warranty) will remain in effect.







SUMMERSET PROFESSIONAL GRILLS

17192 DAIMLER STREET, IRVINE, CA. 92614 | (800) 966-8126 | SUMMERSETGRILLS.COM